

0-10V AHU DX Coil Interface Specification

1 Application

The new 0-10V AHU DX Coil Interface enables BMS capacity demand control of Toshiba Outdoor units connected to a DX Coil (with a field supplied AHU). It is compatible with either a Toshiba LC system (DI /SDI / DI-Big) or a Toshiba VRF system (SMMS-i).

Toshiba LC systems only require the DX Controller, Toshiba VRF systems additionally require a suitably sized VRF DX PMV:-

RBC-DXC031	LC / VRF DX CONTROLLER (0-10V AHU)	
MM-DXV141	VRF DX PMV (16.0kW)	[6.0HP]
MM-DXV281	VRF DX PMV (22.4kW, 28.0kW)	[8.0HP / 10.0HP]

2 System compatibility

Outdoor Unit	Model	HP
VRF SMMSi Outdoor Units [75% - 100% Diversity]	MMY-MAP0804HT8P-E	8 [6, 8]
	MMY-MAP1004HT8P-E	10 [8, 10]
LC DI Outdoor Units	RAV-SM304ATP-E	1.0
	RAV-SM404ATP-E	1.5
	RAV-SM564ATP-E	2.0
	RAV-SM804ATP-E	3.0
	RAV-SM1104ATP-E	4.0
	RAV-SM1404ATP-E	5.0
	RAV-SM1603AT-E	6.0
LC DI-Big Outdoor Units	RAV-SM2224AT8-E	8.0
	RAV-SM2804AT8-E	10.0
LC SDI Outdoor Units	RAV-SP404TP-E	1.5
	RAV-SP564ATP-E	2.0
	RAV-SP804ATP-E	3.0
	RAV-SP1104AT-E	4.0
	RAV-SP1104AT8-E	4.0
	RAV-SP1404AT-E	5.0
	RAV-SP1404AT8-E	5.0
	RAV-SP1604AT8-E	6.0

3 Operating conditions

AHU	<p>The AHU DX Coil Interface is not designed to be used directly with Fresh Air, it must be used in conjunction with either heat recovery exchanger or pre-conditioning heaters / coolers to ensure that the DX Coil Air On limits are not exceeded, in order to ensure reliable operation:-</p> <p style="text-align: right;"> <table border="1"> <tr><td>OA</td><td>Outdoor Air</td></tr> <tr><td>SA</td><td>Supply Air</td></tr> <tr><td>CA</td><td>Coil Air (After Heat Recovery Exchanger)</td></tr> <tr><td>RA</td><td>Return Air</td></tr> <tr><td>EA</td><td>Exhaust Air</td></tr> </table> </p> <p>Cooling mode DX coil "air on" temp: Min: 15°CWB (18°CDB) ~ Max: 24°CWB (32°CDB) Heating mode DX coil "air on" temp: Min: 12°CDB* ~ Max: 28°CDB (*Pull down to 7°C)</p>	OA	Outdoor Air	SA	Supply Air	CA	Coil Air (After Heat Recovery Exchanger)	RA	Return Air	EA	Exhaust Air
OA	Outdoor Air										
SA	Supply Air										
CA	Coil Air (After Heat Recovery Exchanger)										
RA	Return Air										
EA	Exhaust Air										
Outdoor Unit	Refer to specification of Outdoor Unit										

4 Pipe Size, Pipe length and height difference

Model	HP	Liquid Pipe (mm)	Gas Pipe (mm)
MMY-MAP0804HT8P-E	8 [6,8]	ø12.7	Ø22.2
MMY-MAP1004HT8P-E	10 [8,10]	Ø12.7	Ø22.2
RAV-SM304ATP-E	1.0	ø6.4	Ø9.5
RAV-SM404ATP-E	1.5	ø6.4	ø12.7
RAV-SM564ATP-E	2.0	ø6.4	ø12.7
RAV-SM804ATP-E	3.0	ø9.5	ø15.9
RAV-SM1104ATP-E	4.0	ø9.5	ø15.9
RAV-SM1404ATP-E	5.0	ø9.5	ø15.9
RAV-SM1603AT-E	6.0	ø9.5	ø15.9
RAV-SM2224AT8-E	8.0	ø12.7	ø19.1
RAV-SM2804AT8-E	10.0	Ø12.7	ø19.1
RAV-SP404TP-E	1.5	ø6.4	ø12.7
RAV-SP564ATP-E	2.0	ø6.4	ø12.7
RAV-SP804ATP-E	3.0	ø9.5	ø15.9
RAV-SP1104AT-E	4.0	ø9.5	ø15.9
RAV-SP1104AT8-E	4.0	ø9.5	ø15.9
RAV-SP1404AT-E	5.0	ø9.5	ø15.9
RAV-SP1404AT8-E	5.0	ø9.5	ø15.9
RAV-SP1604AT8-E	6.0	ø9.5	ø15.9
Pipe Length / Height Difference	LC -Refer to specification of Outdoor unit VRF – 70m (equivalent length), 10m lift (outdoor to AHU both upper/lower) If the pipe length / lift exceeds the distances shown above please contact the EMEA Engineering Pre Sales Department		
Amount of Additional Refrigerant	Refer to specification of outdoor unit		

5 Product Configuration

5.1 Series Configuration

LC Outdoor Units

Total Size	HP	1.0	1.5	2.0	3.0	4.0	5.0	6.0	8.0	10.0
RBC-DXC031	-	1	1	1	1	1	1	1	1	1
Std. Cooling Capacity (kW)		2.5	3.6	5.0	6.7 SM 7.1 SP	10.0	12.1 SM 12.5 SP	14.0	20.0	23.0
Std. Heating Capacity (kW)		3.4	4.0	5.3 SM 5.6 SP	7.7 SM 8.0 SP	11.2	12.8 SM 14.0 SP	16.0	22.4	27.0
Std. Air volume flow rate (m ³ /hr)		560	600	900	1320	1600	2100	2600	3600	4200

VRF Outdoor Units (includes VRF DX PMV selection)

Total Size	HP	6.0	8.0	10.0
RBC-DXC031	-	1	1	1
MM-DXV141	6.0	1		
MM-DXV281	8.0		1	
	10.0			1
Std. Cooling Capacity (kW)		16.0	22.4	28.0
Std. Heating Capacity (kW)		18.0	25.0	31.5
Std. Air volume flow rate (m ³ /hr)		3300	4300	5000

5.2 Major Specifications

RBC-DXC031 (Controller)

Description	LC / VRF DX Controller in Metal Enclosure, comprising:- <ul style="list-style-type: none"> • MCC-1570 Main PCB • TX-TOS1413 0-10V PCB • 24VAC Transformer • TA Sensor / P-Clamp • TC2 Sensor / Sensor Holder / Sensor fix plate • TCJ Sensor / Sensor Holder / Sensor fix plate • Terminal Block & DI / DO Relays 																					
External Dimensions	H x W x D (mm)	400 x 300 x 150																				
Net Weight	kg	8																				
IP Class	IP65																					
Material	Painted metal Colour Grey (RAL 7035)																					
Extension Lead Length	5m (TA / TC2 / TCJ)																					
Notes: LC / VRF Model Setup required upon installation (SW501_1): <ul style="list-style-type: none"> • OFF (LC Systems - Default) / ON (VRF Systems) Capacity code (DN11) needs to be setup upon installation using wired remote controller (not supplied).																						
	<table border="1"> <thead> <tr> <th>HP</th> <th>1.0</th> <th>1.5</th> <th>2.0</th> <th>3.0</th> <th>4.0</th> <th>5.0</th> <th>6.0</th> <th>8.0</th> <th>10.0</th> </tr> </thead> <tbody> <tr> <td>DN11</td> <td>3</td> <td>6</td> <td>9</td> <td>12</td> <td>15</td> <td>17</td> <td>18</td> <td>21</td> <td>23</td> </tr> </tbody> </table>	HP	1.0	1.5	2.0	3.0	4.0	5.0	6.0	8.0	10.0	DN11	3	6	9	12	15	17	18	21	23	
HP	1.0	1.5	2.0	3.0	4.0	5.0	6.0	8.0	10.0													
DN11	3	6	9	12	15	17	18	21	23													
<ul style="list-style-type: none"> • Only Heating and Cooling Modes are available on the RBC-DXC031 (No Automatic or Fan Only). 																						

MM-DXV141 / MM-DXV281 (VRF DX PMV)

Description	Electronic Pulse Modulating Valve (2 models), comprising:- <ul style="list-style-type: none"> • PMV & Head • TC1 Sensor / Sensor Holder / Sensor fix plate • Strainers 	
MM-DXV141	6 HP Size (PMV Body 60R)	
MM-DXV281	8HP & 10HP Sizes (PMV Body 100R)	
Extension Lead Length	5m (TC1 / PMV)	
Notes: Components supplied loose, requires brazing and local pipework.		

5.3 Control Input / Output Details (0~10V Interface)

Input	Name	Description
AI_1 (T4 & T5)	Capacity Control (0-10V)	Analogue Input to control Capacity demand (Details in next section).
	To ease the integration of the DX interface with the AHU DDC the capacity control is able to operate with either a STEPPED or LINEAR function from the analogue input. To select either a STEPPED or LINEAR response, from the analogue input, use DPSW03 located on the 0~10V IF PCB.	
	DPSW03_02 OFF	STEPPED response to analogue input
	DPSW03_02 ON	Linear response to analogue input
DI_1 (T6 & T7)	ON / OFF	Digital Input to control ON / OFF:- <ul style="list-style-type: none"> • ON (Closed) / OFF (Open). Note the unit will not operate until there is an appropriate 0-10V Capacity Control signal.
DI_2 (T8 & T9)	Mode	Digital Input to control Mode:- <ul style="list-style-type: none"> • HEAT (Closed) / COOL (Open)

Output	Name	Description
DO_1 (T10 & T11)	User defined output - output function set using rotary switch SW1 on the 0~10V interface PCB	SW1_0 = lower than capacity demand SW1_1 = higher than capacity command SW1_2 = cooling oil recovery /heating refrigerant recovery control SW1_3 = cooling output (operation + no error + cooling mode) SW1_4 = heating output (operation + no error + heating mode) SW1_5 = Thermo ON SW1_6 ~ F = No function (for future development)
DO_2 (T12 & T13)	User defined output - output function set using rotary switch SW2 on the 0~10V interface PCB	SW2_0 = lower than capacity demand SW2_1 = higher than capacity command SW2_2 = cooling oil recovery /heating refrigerant recovery control SW2_3 = cooling output (operation + no error + cooling mode) SW2_4 = heating output (operation + no error + heating mode) SW2_5 = Thermo ON SW2_6 ~ F = No function (for future development)

5.4 Analogue Input Control Details

AI_1 Demand 0~10V Stepped Control (SW3_2 OFF)

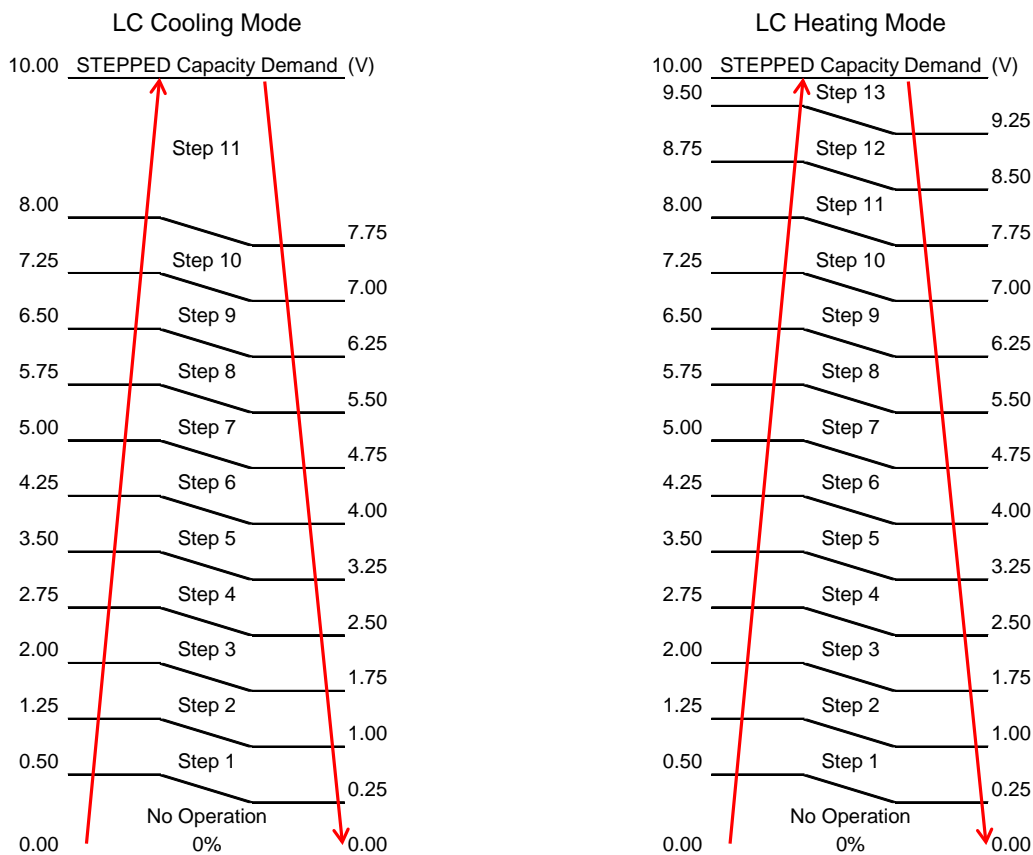

For LC models the control steps are equally spaced between min and max compressor speed (actual max. and min. limits vary by outdoor unit).

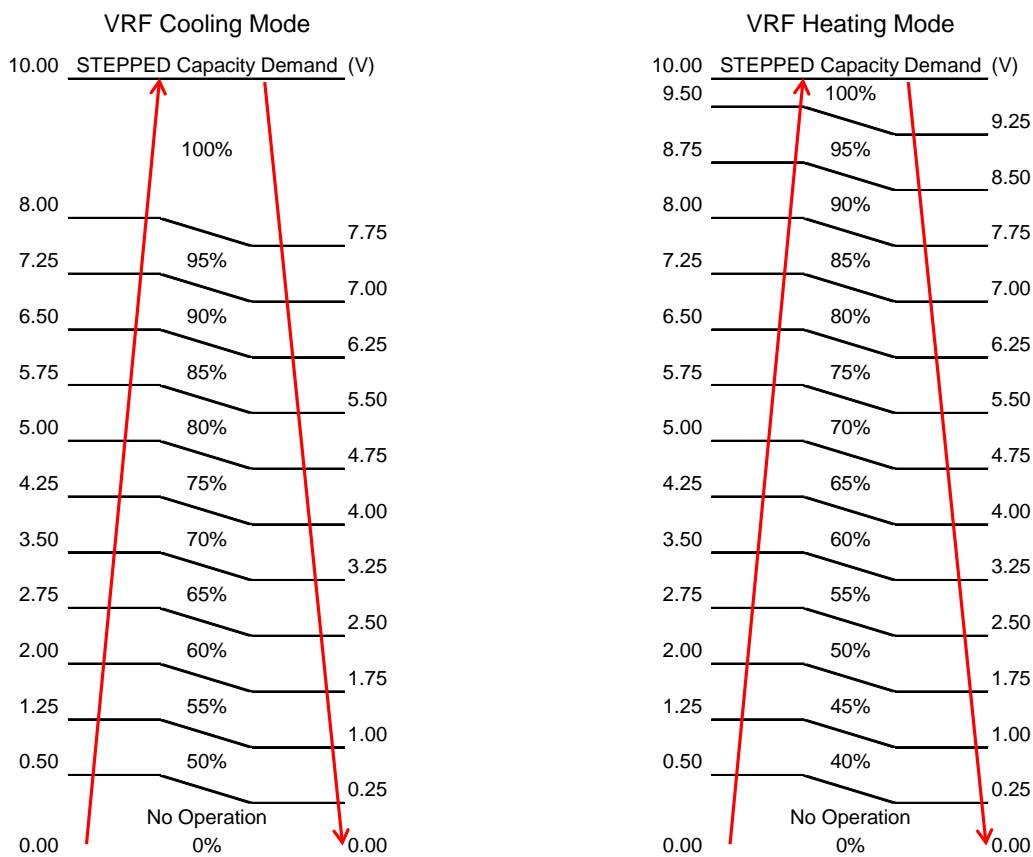

The control of capacity may not be able to be performed according to the state of an air-conditioner (During oil-recover control, defrost etc.).

AI_1 Demand 0~10V Linear Control (SW3_2 ON)

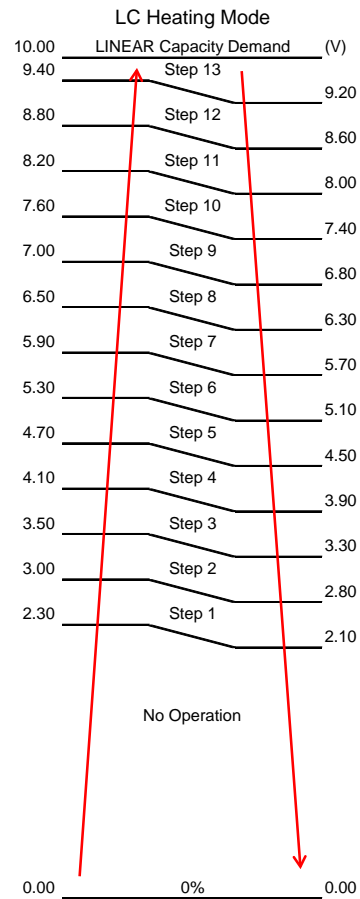
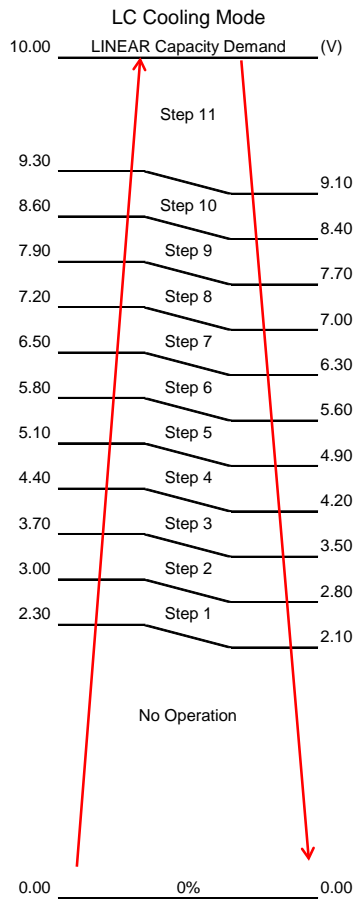

For LC models the control steps are equally spaced between min and max compressor speed (actual max. and min. limits vary by outdoor unit).

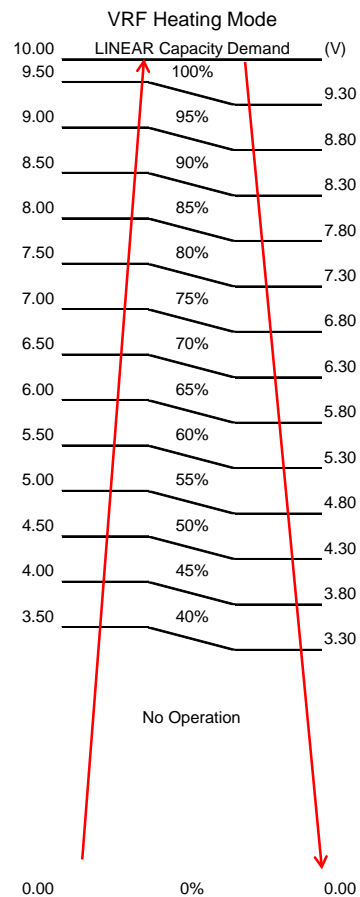
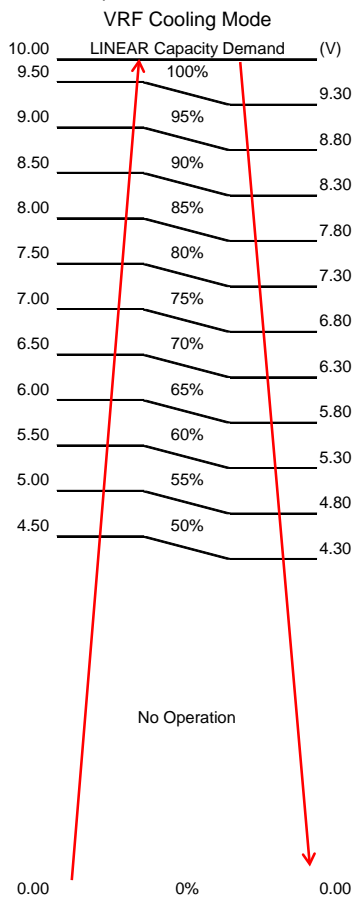

The control of capacity may not be able to be performed according to the state of an air-conditioner (During oil-recover control, defrost etc.).

6 AHU / DX Coil Design
LC Outdoor units

Total Size		HP	1.0	1.5	2.0	3.0	4.0	5.0	6.0	8.0	10.0
RBC-DXC031		-	1	1	1	1	1	1	1	1	1
General	Min. Air volume flow rate (m ³ /hr)		480	522	720	1060	1280	1680	2080	2880	3360
	Max. Air volume flow rate (m ³ /hr)		660	690	1080	1580	1920	2520	3360	4320	5040
	Min. DX Coil internal volume (dm ³)		0.5	0.5	0.8	1	1.5	1.7	1.7	3	3
	Max. DX Coil internal volume (dm ³)		0.7	0.7	1.1	1.4	2.1	2.7	3.2	4.2	5.4
	Recommended Liquid Capillary Distributor Orifice size		2.3 – 2.5	2.8 – 3.0	3.2 – 3.5	3.5 – 4.0	4.5 – 5.0	5.0 – 5.5	5.5 – 6.0	6.5 – 7.0	7.0 – 8.0
Cooling	Min. Cooling Capacity (kW)		0.9 SM	0.9 SM 1.5 SP	1.5 SM 1.2 SP	1.5 SM 1.9 SP	3.0 SM 2.6 SP / 2.6 SP8	3.0 SM 2.6 SP / 2.6 SP8	2.6 SM	9.8 SM	9.8 SM
	Max. Cooling Capacity (kW)		3.0 SM	4.0 SM 4.0 SP	5.6 SM 5.6 SP	8.0 SM 8.0 SP	11.2 SM 12.0 SP / 12.0 SP8	13.2 SM 14.0 SP / 14.0 SP8	16.0 SM	22.4 SM	27.0 SM
	Evaporating Temperature		7°C								
	Suction Superheat		5K								
	Evaporator Air Suction Temp.		27°CDB / 19°CWB								
Heating	Min. Heating Capacity (kW)		0.8 SM	0.8 SM 1.5 SP	1.5 SM 0.9 SP	1.5 SM 1.3 SP	3.0 SM 2.4 SP / 2.4 SP8	3.0 SM 2.4 SP / 2.4 SP8	2.4 SM	9.8 SM	9.8 SM
	Max. Heating Capacity (kW)		4.5 SM	5.0 SM 5.0 SP	6.3 SM 8.1 SP	9.0 SM 11.3 SP	13.0 SM 13.0 SP / 15.6 SP8	16.0 SM 16.5 SP / 18.0 SP8	19.0 SM	25.0 SM	31.5 SM
	Condensating Temperature		44°C								
	Sub Cooling		5K								
	Condenser Air Suction Temp.		20°CDB								

VRF Outdoor Units (plus VRF DX PMV)

Total Size		HP	6.0	8.0	10.0
RBC-DXC031		-	1	1	1
MM-DXV141		6.0	1		
MM-DXV281		8.0		1	
		10.0			1
General	Min. Air volume flow rate (m ³ /hr)		2310	3010	3500
	Max. Air volume flow rate (m ³ /hr)		3960	5160	6000
	Min. DX Coil internal volume (dm ³)		1.7	3	3
	Max. DX Coil internal volume (dm ³)		3.2	4.2	5.4
	Recommended Liquid Capillary Distributor Orifice size		5.5 – 6.0	6.5 – 7.0	7.0 – 8.0
Cooling	Min. Cooling Capacity (kW)		8.0	11.2	14.0
	Max. Cooling Capacity (kW)		16.0	22.4	28.0
	Evaporating Temperature		6.5°C		
	Superheat		5K		
	Evaporator Air Suction Temp.		27°CDB / 19°CWB		
Heating	Min. Heating Capacity (kW)		7.2	10.0	12.6
	Max. Heating Capacity (kW)		18.0	25.0	31.5
	Condensating Temperature		47°C		
	Sub Cooling		10K		
	Condenser Air Suction Temp.		20°CDB		

AHU / DX Coil Design Notes:

Cooling & Heating output figures are based on calculations and 'general' test data. All figures are to be taken as approximations. The properties of the 3rd Party DX Coil will have an effect on the performance of the Outdoor units.

- The DX Coil must be suitable for R410A.
- The design should allow operation as both an Evaporator and a Condenser (Features: Multiple circuits / Liquid Capillary Distributor / Gas Header)
- The counter flow principle must be observed for the DX coil design
- A Drain Pan must be fitted (even if only used in Heat mode) due to defrost cycles
- It is recommended to fit droplet eliminator plates in the discharge air stream if used in Cool mode.
- 1:1 Connection: The DX Interface (0-10V) must be connected 1:1 with Toshiba outdoor units (LC & VRF)

DX Coil Manufacturing:

<ul style="list-style-type: none"> DX Coil & Pipework Design Pressure: 4.15MPa DX Coil & Pipework Burst Pressure (withstand): 12.45MPa (more than 3 x Design Pressure) 						
<p>DX Coil Contamination:</p> <ul style="list-style-type: none"> Ensure the DX coil is cleaned, using detergent, after manufacture to remove contaminants from the coil Do not use chlorinated detergent during the cleaning process Do not leave flux on or inside the DX coil 						
<p>DX Coil & Pipework Contamination (Allowable Limits):</p> <table style="width: 100%; border: none;"> <tr> <td style="width: 50%;">Residual water amount</td> <td style="width: 50%; text-align: right;">0.6 mg / m</td> </tr> <tr> <td>Residual oil amount</td> <td style="text-align: right;">0.5 mg / m</td> </tr> <tr> <td>Amount of solid contaminants</td> <td style="text-align: right;">1.8 mg / m</td> </tr> </table> <ul style="list-style-type: none"> DX coil contaminants must be equal to or less than the values shown above. The allowable contaminant levels shown assumes Ø9.52mm copper tube has been used for the manufacture of the DX coil 	Residual water amount	0.6 mg / m	Residual oil amount	0.5 mg / m	Amount of solid contaminants	1.8 mg / m
Residual water amount	0.6 mg / m					
Residual oil amount	0.5 mg / m					
Amount of solid contaminants	1.8 mg / m					

LC Models: Recommended No. of Ref. Circuit by DX-Coil U-Pipe Dia. and DX Coil Size (HP)

U-Pipe Diameter	HP	No. of Circuits	
		Min	Max
8.00	1	1	2
	1.5	2	2
	2	2	3
	2.5	3	4
	3	3	5
	4	4	7
	5	5	8
	6	6	10
	10	10	14
9.52	1	1	1
	1.5	1	1
	2	2	2
	2.5	2	3
	3	3	3
	4	3	5
	5	4	6
	6	5	7
	8	6	10
10	8	12	
12.70	2	1	1
	2.5	1	2
	3	2	2
	4	2	3
	5	3	3
	6	3	4
	8	4	6
	10	5	7

VRF Models: Recommended No. of Ref. Circuit by DX-Coil U-Pipe Dia. and DX Coil Size (HP)

U-Pipe Diameter	HP	No. of Circuits	
		Min	Max
8.00	6.0	6	10
	8.0	8	12
	10.0	10	14
9.52	6.0	5	7
	8.0	6	10
	10.0	8	12
12.70	6.0	3	4
	8.0	4	6
	10.0	5	7

DX Controller Installation

Installation Site	<p>Avoid Direct Sunlight DO NOT install outside Avoid locations exposed to steam or oil vapours Avoid locations where combustible gas may leak, settle or be generated. Avoid installation near machines emitting high-frequency waves Avoid places where acidic solutions are frequently used Avoid places where sulphur based or other sprays are frequently used Avoid places where vibrations may occur.</p>
Notes	<p>To maintain waterproof integrity IP65 glands must be used through the gland plate. To avoid damage; when making holes for cable glands, please first remove the Gland Plate from the DX Coil CONTROLLER</p>
Ambient Temperature	0°C to 40°C
Ambient Humidity	<p>Relative humidity 10 ~ 90% (or less). No dew condensation allowed. If the DX-Controller is to be installed where dew condensation could form, locally sourced insulation should be fitted to avoid condensation.</p>
Installation Angle	Vertical Installation

Sensor Connections

Installation	<p>Sensor holders MUST be brazed to the DX Coil to ensure reliable temperature sensing. Follow the information in the DX Controller Installation Manual for details.</p>
Wire Connections	<p>The DX Interface is pre-wired with TCJ and TC2 sensors which have a 5m extension cable (this is the maximum length and cannot be extended). If these Sensors are removed during installation ensure the sensors are reconnected to the DX-Controller main PCB (MCC-1570) as shown below:</p> <ul style="list-style-type: none"> • TA Sensor (YEL Plug [2 Pin]) > (YEL Socket [2 Pin]) Extension Cable (YEL Plug [2 pin]) > (YEL Socket [2 Pin]) MCC-1570 CN104 • TCJ Sensor (RED Plug [2 Pin]) > (RED Socket [2 Pin]) Extension Cable (RED Plug [2 pin]) > (RED Socket [2 Pin]) MCC-1570 CN102 • TC2 Sensor (BLK Plug [2 Pin]) > (BLK Socket [2 Pin]) Extension Cable (BLK Plug [2 pin]) > (BLK Socket [2 Pin]) MCC-1570 CN101 <p>Take care to re-connect them correctly. The cables should be installed with a U-bend at Sensor ends to stop water dripping into components. The sensor cables vinyl tube can withstand up to 105°C be careful to keep clear of high temperature parts. The extension cables' connectors are not IP rated. Ensure that they are located within the AHU.</p>

VRF DX PMV Installation

Installation Environment	<p>Avoid locations in direct sunlight.</p> <p>Insulation should be fitted to PMV assembly (locally sourced).</p> <p>Ideally the DX PMV should be contained within the AHU. If installed outside, a cover (locally sourced) should be fitted to protect from wind and rain in addition to Insulation.</p>
Installation	<p>The supplied components need to be assembled on to the DX Coil using custom locally sourced pipework.</p> <p>The PMV (Pulse-Motor-Valve) must be NOT installed upside down (motor-head on bottom).</p> <p>The connection angle between PMV body and PMV head is fixed at the factory (using thread lock) and should not be changed. The PMV head should not be removed from PMV body.</p> <p>Carefully handle and prepare the PMV when fitting to prevent ingress from foreign matter such as dust or water.</p>
Brazing	<p>Cautions when Brazing PMV</p> <p>A) Whilst brazing, the PMV body and PMV head must be water cooled to keep the component's temperature below 100°C.</p> <p>B) Whilst brazing, nitrogen gas must flow through the PMV valve and pipework to prevent internal oxidization.</p> <p>C) Prevent cooling water from getting inside the PMV valve and connector of the lead during brazing.</p> <p>D) Take care not to damage the PMV cables during brazing.</p>
Wire Connections	<p>The PMV and TC1 sensors are provided with a 5m extension cable (this is the maximum length and cannot be extended).</p> <p>These extension cables need to be plugged into the DX-Controller main PCB (MCC-1570):-</p> <ul style="list-style-type: none"> • PMV Head (BLU Plug [6 Pin]) > (BLU Socket [6 Pin]) Extension Cable (BLU Plug [6 pin]) > (BLU Socket [6 Pin]) MCC-1570 CN82 • TC2 Sensor (BRN Plug [3 Pin]) > (WHI Socket [3 Pin]) Extension Cable (WHI Plug [3 pin]) > (BRN Socket [3 Pin]) MCC-1570 CN100 <p>Take care to connect them correctly.</p> <p>The cables should be installed with a U-bend at PMV and Sensor ends to stop water dripping into components.</p> <p>The PMV & sensor cables vinyl tube can withstand up to 105°C be careful to keep clear of high temperature parts. The extension cables' connectors are not IP rated ensure that they are within the AHU.</p>

7: Protection Function Summary

- Protection Controls varies by Outdoor unit, please see appropriate service manual for full details

LC Protection	Summary
Freeze prevention control (Low temperature release)	In Cooling Mode prevents low DX-Coil temperatures by controlling compressor speed (based on TC2/TCJ sensor temperature)
High-temp release control	In Heating Mode prevents high DX-Coil temperatures by controlling compressor speed (based on TC2/TCJ sensor temperature).
PMV Control (Outdoor unit)	In Cooling Mode the PMV is usually controlled to maintain a difference between TS sensor and TC2 sensor (between 1K & target value). In Heating Mode the PMV is usually controlled to maintain a difference between TS sensor and TE sensor (between -1K & target value).
Discharge temperature release control	When Discharge temperature (TD) does not fall (or rapidly rises due to PMV control) this control reduces the compressor speed.
Coil heating control (Outdoor unit case heater)	This control heats up the compressor by turning on the stopped compressor instead of a case heater to prevent stagnation of refrigerant (based on TD and TE sensors). Before test run after installation turn on the power of the compressor for the specified time otherwise a trouble of the compressor may be caused. Similarly, when starting compressors after a long period of no power supply, it is recommended that the power supply be turn on for a while before operation is resumed.
Short intermittent operation prevention control	To protect the compressor, for 3 to 10 mins after operation start the compressor can continue to operate even if it receives zero demand signal.
Current release control	To protect the inverter the input current is continuously measured. This control can reduce the compressor speed to ensure that the input current does not exceed its limit.
Current release value shift	In Cooling Mode the Current release limit can be reduced based on TO sensor.
Over-current protection control	When over current is detected the compressor stops. This automatically re-starts after 2 min 30 sec. If the detection is repeated 8 times the unit will not re-start.
High Pressure release control	In Cooling Mode restrains abnormal rising of high pressure by reducing compressor speed (based on TL sensor temperature). In Heating Mode restrains abnormal rising of high pressure by reducing compressor speed (based on TC2/TCJ sensor temperature). This control can stop the compressor, which will automatically re-start after 2 mins 30 secs. If the detection is repeated 10 times the unit will not re-start.
Defrost control	In Heating mode a defrost operation can be performed to reduce ice build-up on the Outdoor unit (based on TE sensor). During Defrosting the refrigerant cycle is reversed temporarily cooling the DX-Coil. The defrost operation lasts for up to 10 mins (or earlier based on TE), and can occur every 40 mins (based on TE sensor).
High-pressure switch / Compressor case thermostat	Details regarding the wiring of the Central Control BUS can be found in the installation manual of the Central Control devices (Optional).

VRF Protection	Summary
Freeze prevention control (Low temperature release)	In Cooling Mode prevents low DX-Coil temperatures by controlling compressor speed (based on TC1/TC2/TCJ sensor temperature).
Cooling oil (refrigerant) recovery control	This control periodically increases flow-rate to ensure refrigerant oil does not build up in inter-unit gas pipes (which can occur when operating command is inadequate, or while cooling is progressed under low ambient conditions). During this control the compressors are operated at a target speed, and DX-Coil PMV is opened to a certain degree. Recovery operation duration is approx. 2 mins and normally takes place every 2 hrs. Upon completion of recovery control normal Cooling operation resumes.
Heating refrigerant (oil) recovery control (Heating Start up Control)	This control periodically increases flow-rate to ensure liquid refrigerant trapped inside the DX-Coil. It also serves the purpose of recovering DX-Coil / Outdoor refrigerant after defrosting and recovering oil present in outdoor heat exchangers during heating overload operation. During this control the compressors are operated at a target speed, and DX-Coil PMV is opened to a certain degree. Recovery operation duration is 2 to 10 mins and normally takes place every 1 hr. Upon completion of recovery control normal Heating operation resumes. Recovery operation normally takes place after defrosting.

VRF Protection (cont.)	Summary
Short intermittent operation prevention control	To protect the compressor, for 5 mins after operation start the compressor will continue to operate even if it receives zero demand signal.
Defrost control	In Heating mode a defrost operation can be performed to reduce ice build-up on the Outdoor unit (based on TE1 sensor). During Defrosting the refrigerant cycle is reversed temporarily cooling the DX-Coil. The defrost operation terminates based on TE1, and can re-occur every 55 mins. While the outdoor unit is Defrosting the DX-Coil PMV is opened to a certain degree. Heating Recovery operation normally takes place after defrosting
High Pressure release control	This control can perform a staged shutdown of the compressors based on PD sensor value and PO limit:- Pd ≥ PO = 3.45MPa Compressor No.2 (in start-up order) is shutdown. Pd ≥ PO = 3.5MPa Compressor No.1 (in start-up order) is shutdown. The compressor(s) will automatically re-start after 2 mins 30 secs.
Case Heater control	There are 2 types of case heaters: a compressor case heater and an accumulator case heater. This control function is aimed at preventing the accumulation of refrigerant in those cases, and is performed by all outdoor units. Before test run after installation turn on the power of the compressor for the specified time otherwise a trouble of the compressor may be caused. Similarly, when starting compressors after a long period of no power supply, it is recommended that the power supply be turn on for a while before operation is resumed.
A3-IPDU control	<p>1) Current Release Control To protect the inverter the input current is continuously measured. This control can reduce the compressor speed to ensure that the input current does not exceed its limit.</p> <p>2) Heat sink temperature detection control This control function is aimed at protecting IGBT from over-heating via a thermistor (TH sensor). This control can increase outdoor fan speed and shutdown the compressors. This control can stop the compressor, which will automatically re-start after 2 mins 30 secs. If the detection is repeated 4 times the unit will not re-start (error code P07).</p> <p>3) Overcurrent protection When the overcurrent protection circuit on IPDU PCB detects an abnormal current the compressor is shutdown. The compressor is re-started after 2 min 30 secs and the error count is recorded. If the compressor operates for at least 10 mins the error count is cleared. If the detection is repeated 8 times the error is confirmed as final.</p> <p>4) High Pressure SW control When high pressure switch is activated the compressor is stopped, which will automatically re-start after 2 mins 30 secs. If the detection is repeated 4 times the unit will not re-start (error code P04).</p>

8 Cable specifications

Description	Max. Cable Length (m)	Cable Specification
LC Outdoor / Indoor Interconnect	See Outdoor unit Installation Manual	H07 RH-F / 60245 IEC 66 (1.5mm ² or more)
VRF DX Controller Power Supply	See Outdoor unit Installation Manual	60245 IEC 57
Analogue input (AI1)	200	Screened cable: 0.5 ~ 1.0mm ²
Digital input (DI1)	100	Non screened cable: 0.5 ~ 1.0mm ²
Digital output (DO1 / DO2)	500	Non screened cable: 0.5 ~ 1.0mm ²
Remote Controller (AB)	500	Non screened cable: 0.75 ~ 2.5mm ²
VRF Control (U1/U2)	1000	Screened cable: ≥1.5mm ²

9 Interface requirements for controller

Description	Notes / Control Logic									
Electrical connection to controller	<p>LC connection</p> <p>LC = Outdoor (E,1,2,3)</p> <p>VRF connection</p> <p>VRF = Power Supply (1,2 Only) 1Ph 220-240VAC 50Hz</p>									
System selection (LC or VRF)	<table border="1"> <thead> <tr> <th>System</th> <th>VRF</th> <th>LC</th> </tr> </thead> <tbody> <tr> <td>SW501_2</td> <td>OFF</td> <td>OFF</td> </tr> <tr> <td>SW501_1</td> <td>ON</td> <td>OFF</td> </tr> </tbody> </table> <p>DPSW 501 located on main indoor PCB (MCC-1570) in the RBC-DXC031 DX controller</p>	System	VRF	LC	SW501_2	OFF	OFF	SW501_1	ON	OFF
System	VRF	LC								
SW501_2	OFF	OFF								
SW501_1	ON	OFF								
MCC-1570 PCB CN60: Defrost output	<p>Locally supplied cable</p> <p>To DDC controller</p>									
MCC-1570 PCB CN60: Cooling / heating start up (VRF only)	<p>Locally supplied cable</p> <p>To DDC controller</p>									

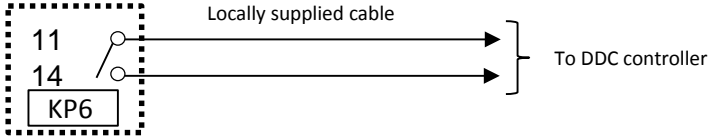
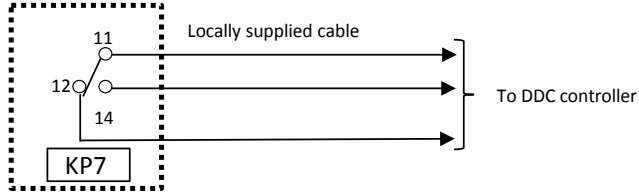
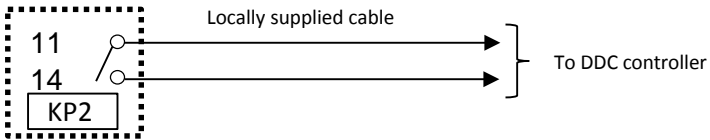
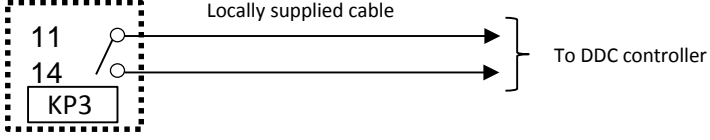
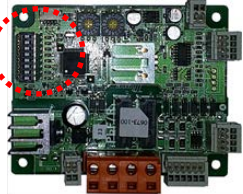
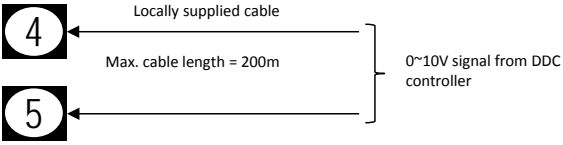
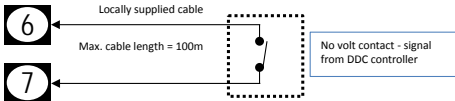
Description	Notes / Control Logic				
MCC-1570 PCB CN60: Pre-defrost output (VRF only)					
MCC-1570 PCB CN60: Cooling / heating mode output	 <p data-bbox="555 607 1082 667"> Cooling mode output connections = 11 + 12 Heating mode output connections = 11 + 14 </p>				
MCC-1570 PCB CN60: Fan operation output					
MCC-1570 PCB CN61: Alarm output					
0~10V IF PCB SW03_2: STEPPED / LINEAR response	 <table border="1" data-bbox="900 1205 1490 1348"> <tr> <td>DPSW03_2 OFF</td> <td>STEPPED response (Default)</td> </tr> <tr> <td>DPSW03_2 ON</td> <td>LINEAR response</td> </tr> </table>	DPSW03_2 OFF	STEPPED response (Default)	DPSW03_2 ON	LINEAR response
DPSW03_2 OFF	STEPPED response (Default)				
DPSW03_2 ON	LINEAR response				
0 ~10V IF PCB AI1: Analogue input (0~10V)					
0 ~10V IF PCB DI1: Digital input (external ON/OFF)					

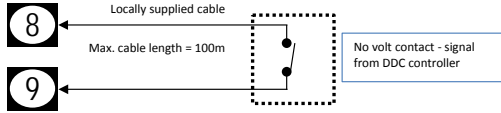
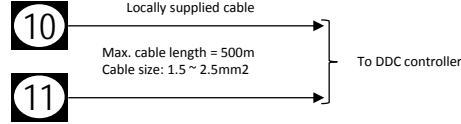
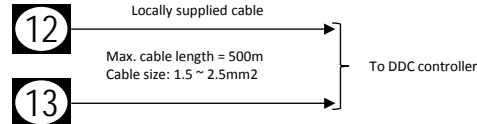
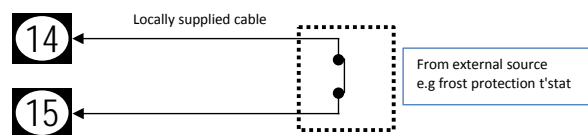
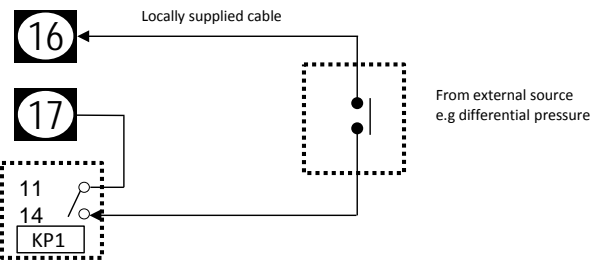
Description	Notes / Control Logic
0 ~10V IF PCB DI2: Digital input Operating mode change	
0 ~10V IF PCB DO1: Digital output User defined Function defined by rotary switch SW1	
0 ~10V IF PCB DO2: Digital output User defined Function defined by rotary switch SW2	
MCC-1570 PCB CN34: Safety contact input	 <p data-bbox="555 1052 1449 1108">Note: If the safety contact input is not used then terminals 14 & 15 must be bridged</p> <p data-bbox="555 1142 1500 1198">If the external contact is OPEN for 1 minute or more then the system will STOP and a P10 error code will be generated</p>
MCC-1570 PCB CN80: Fan error input	 <p data-bbox="555 1534 1492 1590">When KP1 relay is energised and the external contact is CLOSED the system will STOP and a L30 error code will be generated</p>

10 Related cautions

1) Installation work

(1) Installation work

- Secure enough service space for replacement of the DX-PMV and the thermistors.

After the AHU controller is installed, address setting and unit capacity setting is necessary. Refer to the installation manual for the setting method.

- Refer to the outdoor unit installation manual or the data book for installation of the outdoor unit.

(2) Test run

- Turn on the main power of the unit at least 12 hours before test run to power the crankcase heater. Insufficient powering time may result in compressor damage.

- Ensure the analogue input is voltage is set to $\geq 4.5V$ before starting the test run.

- As the capacity setting is made at initial setting, a remote controller is necessary. Remove the remote controller after making the initial settings if it is not used.

(Refer to the installation manual for remote controller for more details.)

- (3) Operation control
If the error display appears on the remote controller, do not reset an error by yourself. Contact the service firm or the dealer.
- Refer to the data book for system controller when using the system controller.
- (4) Service
- Regular maintenance is required to prolong the life of the units. It is recommended that the maintenance contract be concluded with a maintenance firm.

11. Warranty

- Specifications of AHU and compatibility with National / Local regulations must be confirmed by your company.
- Selection of an appropriate AHU (with appropriate specifications to match those of units connected to the AHU such as configuration, dimension, life-span, vibration, noise level, or features) must be made by your company.
- Toshiba Carrier UK Ltd shall not be liable for any damage to the entire system or the AHU main body caused by connected AHU with wrong specification or wrong usage of AHU.
- Toshiba Carrier UK Ltd shall not be liable for any damage to the outdoor units caused by AHU damage.

12 DX Controller Dimensions

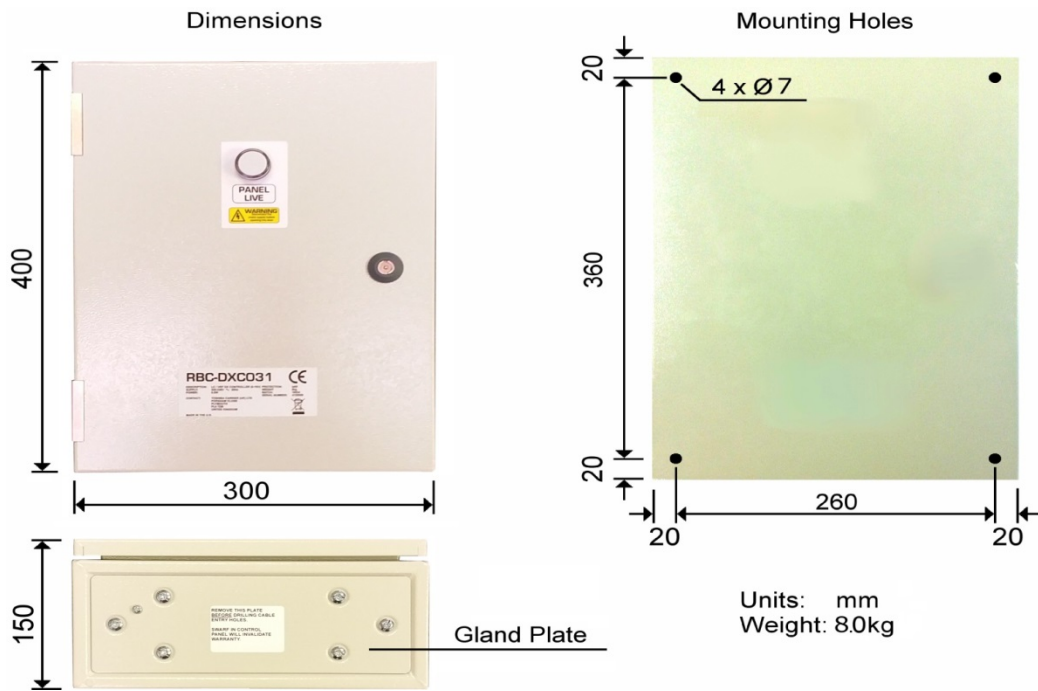

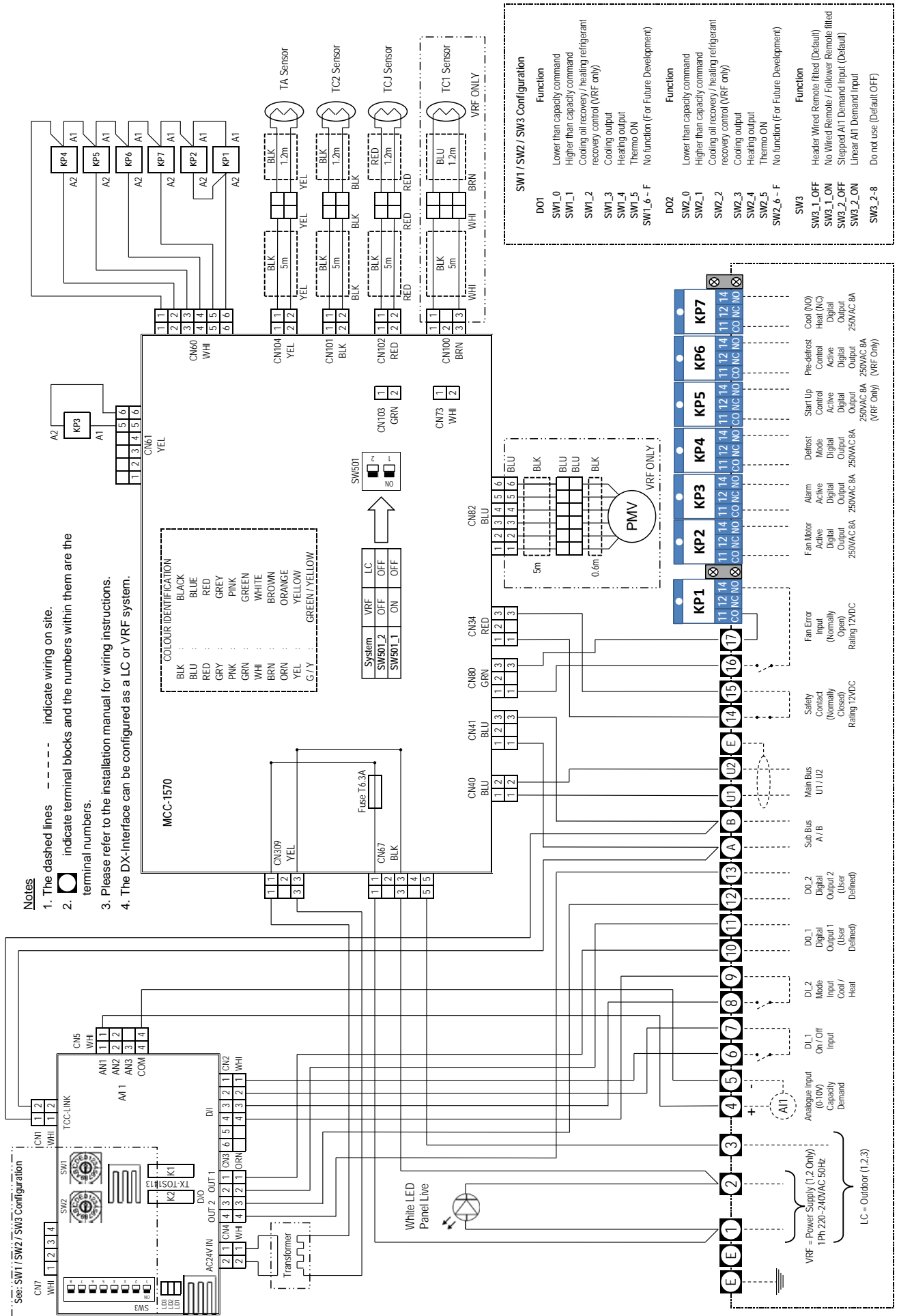

Notes

- The dashed lines indicate wiring on site.
- indicate terminal blocks and the numbers within them are the terminal numbers.
- Please refer to the installation manual for wiring instructions.
- The DX-Interface can be configured as a LC or VRF system.

COLOUR IDENTIFICATION

BLK	BLACK
BLU	BLUE
RED	RED
GRY	GREY
PNK	PINK
GRN	GREEN
WHI	WHITE
BRN	BROWN
ORN	ORANGE
YEL	YELLOW
G/Y	GREEN/YELLOW



System	VRF	LC
SW50_2	OFF	OFF
SW50_1	ON	OFF

SW1 / SW2 / SW3 Configuration

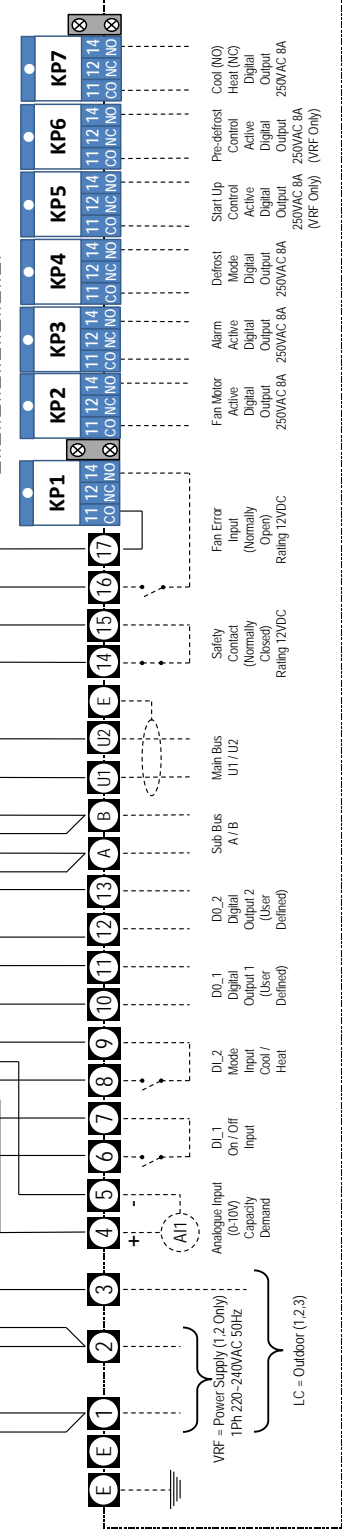
SW	Function
SW1_0	Lower than capacity command
SW1_1	Higher than capacity command
SW1_2	Cooling oil recovery / heating refrigerant recovery control (VRF only)
SW1_3	Cooling output
SW1_4	Heating output
SW1_5	Thermo ON
SW1_6 - F	No function (For Future Development)
SW2_0	Lower than capacity command
SW2_1	Higher than capacity command
SW2_2	Cooling oil recovery / heating refrigerant recovery control (VRF only)
SW2_3	Cooling output
SW2_4	Heating output
SW2_5	Thermo ON
SW2_6 - F	No function (For Future Development)
SW3	Header
SW3_1	Header Wired Remote filled (Default)
SW3_1_ON	No Wired Remote / Follows Remote filled
SW3_2	Linear A/H Demand Input (Default)
SW3_2_ON	Linear A/H Demand Input
SW3_2-8	Do not use (Default OFF)



Toshiba Carrier (UK) Ltd
Porsham Close
Belliver Industrial Estate
Plymouth
Devon
United Kingdom
PL6 7DB

 +44 (0) 1752 753200
 +44 (0) 1752 753222